

SERVIZI AL CLIENTE

COSTRUITO A MODENA, RICAMBI SEMPRE DISPONIBILI.

Pronta disponibilità dei ricambi di carrozzeria e facilità di manutenzione con accesso immediato agli organi meccanici del telaio.



Coach & Bus
Barbi

BARBI COACH & BUS srl

Sede legale/Registered Office

Viale della Libertà 21 - 41037 Mirandola MO

Tel.: +39 338 6504124

info@barbicoachandbus.eu

CATALOGO

DELLE PARTI

DI RICAMBIO

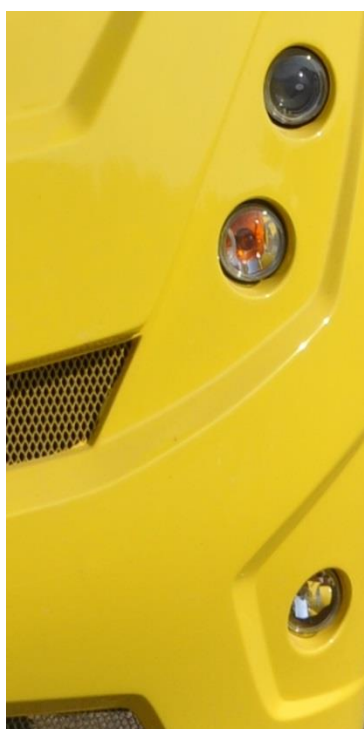

AVVERTENZE

I componenti non funzionanti o danneggiati debbono essere sostituiti con ricambi forniti da Barbi coach and bus; in ogni caso assicurarsi che si tratti di ricambi originali **Barbi** Coach & Bus.

Il montaggio di ricambi e/o accessori che non sono approvati da **Barbi** Coach & Bus, può danneggiare il veicolo ed alterarne la propria funzionalità. Per questa ragione vi consigliamo di rivolgervi sempre ed esclusivamente a **Barbi**. I lavori di riparazione che vengono effettuati per danni causati da incuria o manovre errate, non verranno da detto stabilimento considerati come coperti da garanzia.







CATALOGO PARTI DI RICAMBIO

Questo catalogo mostra gli articoli (in vista esplosa e codificata, oppure fotografica) che sono forniti da **Barbi** Coach & Bus come parti di ricambio.

Questo catalogo può essere facilmente consultato servendosi dell'indice all'inizio, dove sono elencate tutte le tavole.

Il continuo sviluppo della tecnica e della qualità del prodotto richiede un costante aggiornamento dei modelli costruiti. Pertanto i dati contenuti in questa pubblicazione non sono definitivi.

La **Barbi** Coach & Bus si riserva il diritto, senza modificare le caratteristiche dei modelli qui descritti, di modificare in ogni momento e per qualsiasi ragione i componenti, i dettagli e gli accessori forniti, senza l'obbligo di aggiornare la presente pubblicazione.

Le pagine di ogni eventuale aggiornamento, devono essere sistematicamente inserite in questo catalogo, in sostituzione od in aggiunta alla pagina in vigore prima, usando lo stesso numero di pagina e tavola.



INDICE :

Sole 100 Scuolabus

pag.6	Illuminazione esterna anteriore e laterale
pag.7	<i>COD. Illuminazione esterna anteriore e laterale</i>
pag.8	Illuminazione esterna posteriore
pag.9	<i>COD. Illuminazione esterna posteriore</i>
pag.10	Impianto tergi
pag.11	<i>COD. Impianto tergi</i>
pag.12	Riscaldamento
pag.13	<i>COD. Riscaldamento</i>
pag.14	Cruscotto e Plance
pag.15	<i>COD. riscaldamento</i>
pag.16	Sportelli lato DX
pag.17	<i>COD. sportelli lato DX</i>
pag.18	Sportelli lato SX
pag.19	<i>COD. sportelli lato SX</i>
pag.20	Cristalli
pag.21	<i>COD. Cristalli</i>
pag.22	Climatizzazione
pag.23	<i>COD. Climatizzazione</i>
pag.24	Climatizzazione Autista
pag.25	<i>COD. Climatizzazione Autista</i>
pag.26	Sedili



Accessori d'emergenza

Sole 100 Scuolabus

pos.	codice	quantità	U.M.	descrizione
1	B190001	1	NR	Borsina pronto soccorso IVECO
2	B190002	1	NR	Cassetta pronto soccorso
3	B190004	1	NR	Scritta Tirare la leva e spingere la porta
4	B190003	1	NR	Estintore
5	B190006	6	NR	Martelletto rompivetro
6	B190007	1	NR	Adesivo limite velocita 100KM/h
7	B190008	1	NR	Adesivo limite velocita 80KM/h
8	B190009	6	NR	Targhetta uscita emergenza
9	B190010	1	NR	Targhetta cassetta pronto soccorso
10	B190011	1	NR	Targhetta estintore
11	B190012	1	NR	Targhetta uscita emergenza rompivetro
12				
13			NR	
14			NR	
15			NR	
16			NR	
17			NR	
18			NR	
19			NR	

Accessori d'emergenza



11



3



10

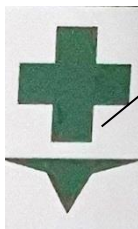

9

USCITA DI EMERGENZA

8



4

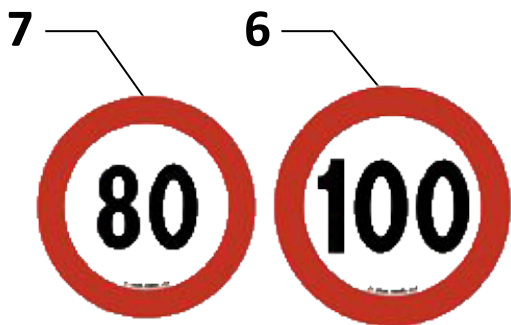

7

6

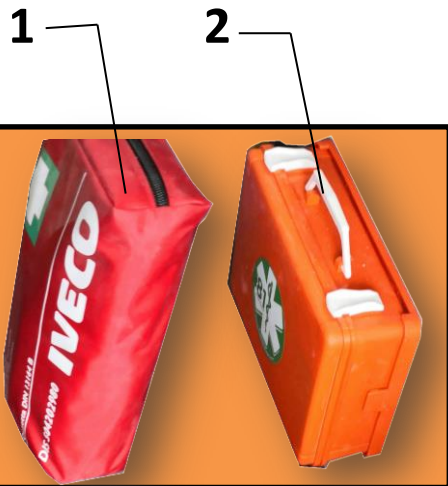

1

2



5

pag.27	<i>COD. Sedili</i>
pag.28	Porta autista
pag.29	<i>COD. porta autista</i>
pag.30	Porta passeggeri
pag.31	<i>COD. porta passeggeri</i>
pag.32	Porta emergenza
pag.33	<i>COD. Porta emergenza</i>
pag.34	Elementi frontali
pag.35	<i>COD. Elementi frontali</i>
pag.36	Elementi posteriori
pag.37	<i>COD. Elementi posteriori</i>
pag.38	Parti interne
pag.39	<i>COD. Parti interne</i>
pag.40	Accessori Emergenza
pag.41	<i>COD. Accessori Emergenza</i>
pag.42	
pag.43	



ILLUMINAZIONE ESTERNA ANTERIORE E LATERALE

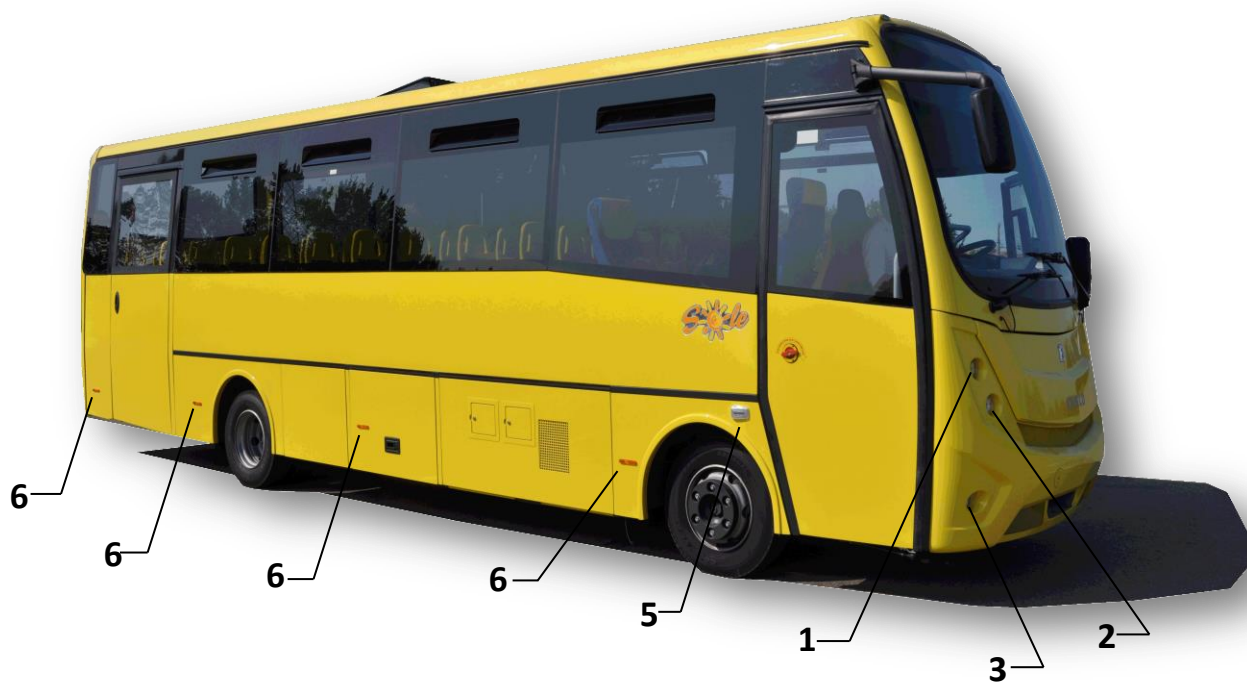

Parti interne

Sole 100 Scuolabus

pos.	codice	quantità	U.M.	descrizione
1	B170001	1	NR	Aspiratore
2	B180001	4	NR	Cassa audio bianca tonda (optional)
3	B160201	2	NR	Luce led sopra autista
4	B170002	1	NR	Botola emergenza
5	B170003	1	NR	Tenda parasole
6	B340001	1	NR	Maniglione di salita passeggeri
7	B160100	1	NR	Specchio retrovisore interno autista
8	B160202	1	NR	Luce gradino salita passeggeri
9	B160203	4	NR	Gancio cofano motore
10	B160204	1	NR	Maniglia salita porta passeggeri
11	B160205	1	NR	Maniglia salita sedile accompagnatore
12			NR	
13			NR	
14			NR	
15			NR	
16			NR	
17			NR	
18			NR	
19			NR	

PARTI INTERNE

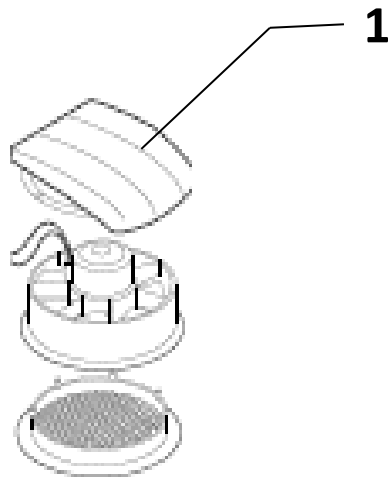
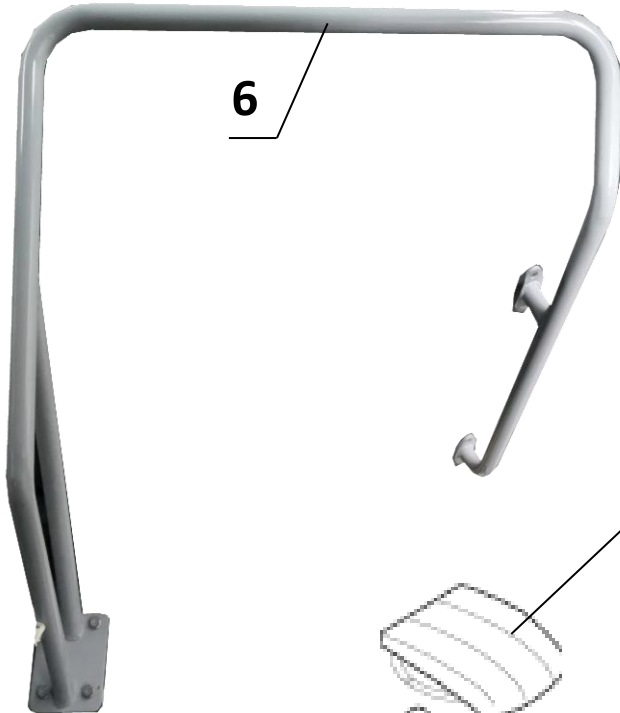
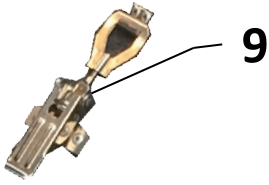
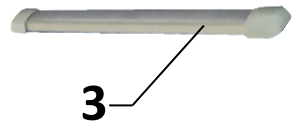
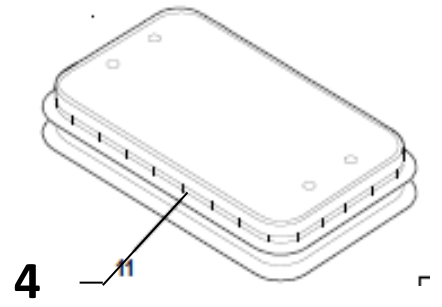
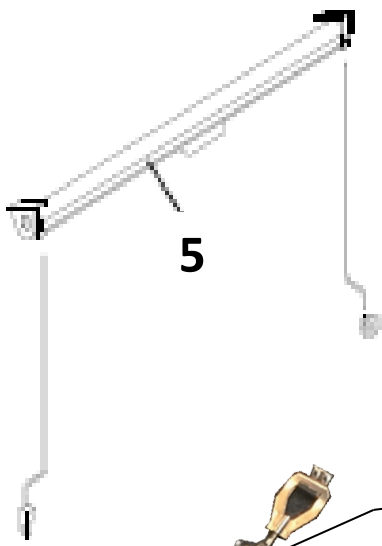

ILLUMINAZIONE ESTERNA ANTERIORE E LATERALE

Sole 100 Scuolabus

pos.	codice	quantità	U.M.	descrizione
1	B160003	2	NR	Proiettori abbaglianti e anabbaglianti
2	B160001	2	NR	Indicatore di direzione anteriore e luce di posizione anteriore
3	B160002	2	NR	Proiettore fendinebbia anteriore e luci diurne
4	B160005	2	NR	Luci di ingombro anteriori
5	B160004	1	NR	Luce indicatore di direzione
6	B160006	8	NR	Luce di posizione laterale «Sidemarker»
7	B160004	1	NR	Luce indicatore di direzione
8			NR	
9			NR	
10			NR	
11			NR	
12			NR	
13			NR	
14			NR	
15			NR	
16			NR	
17			NR	
18			NR	
19			NR	

ILLUMINAZIONE ESTERNA POSTERIORE

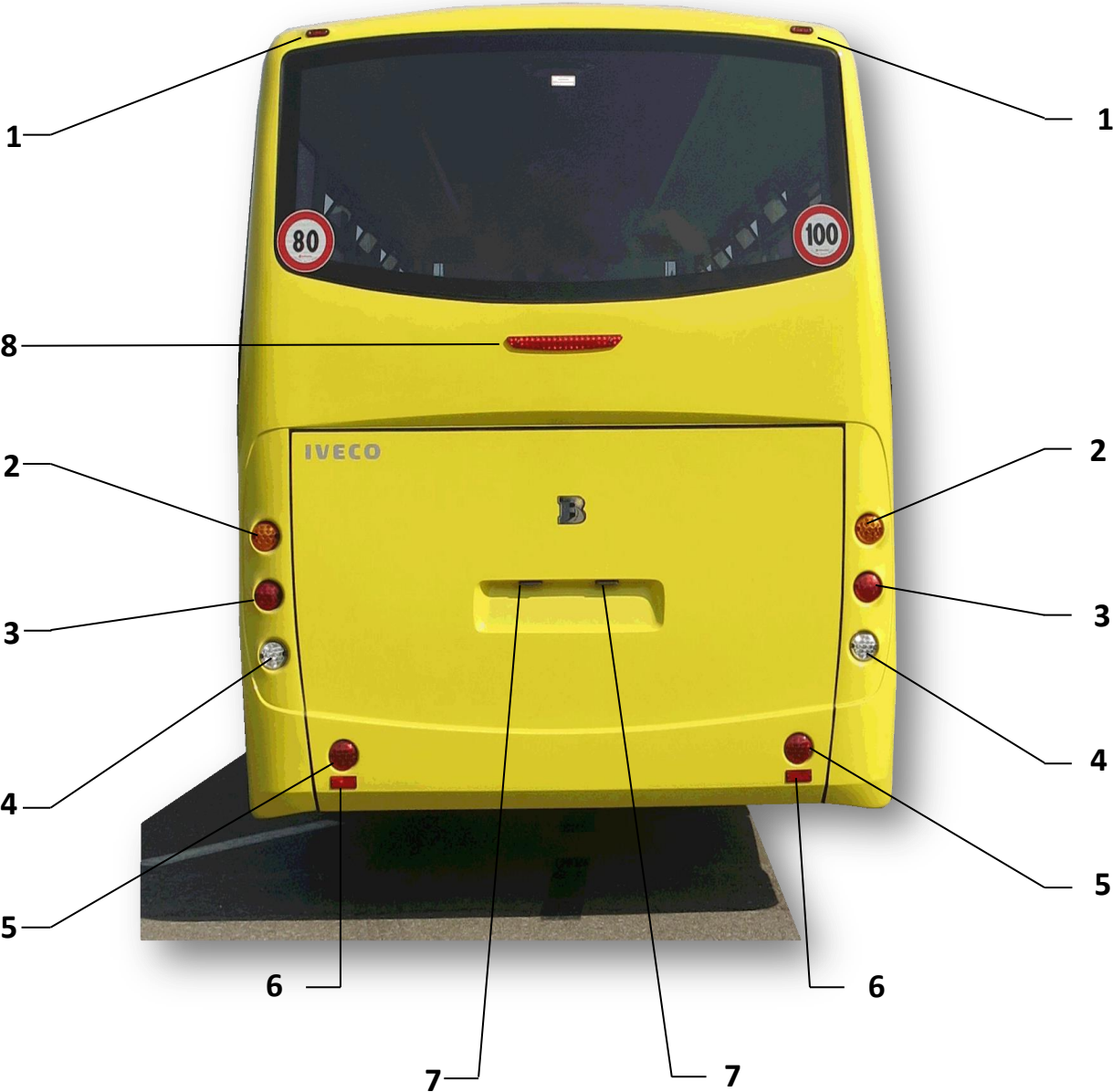

Elementi posteriori

Sole 100 Scuolabus

pos.	codice	quantità	U.M.	descrizione
1	B150041	1	NR	Videocamera posteriore (OPTIONAL)
2	B346220	1	NR	Testata posteriore vetroresina
3			NR	
4			NR	
5			NR	
6			NR	
7			NR	
8			NR	
9			NR	
10			NR	
11			NR	
12			NR	
13			NR	
14			NR	
15			NR	
16			NR	
17			NR	
18			NR	
19			NR	
20			NR	Pag.37

Elementi Posteriori

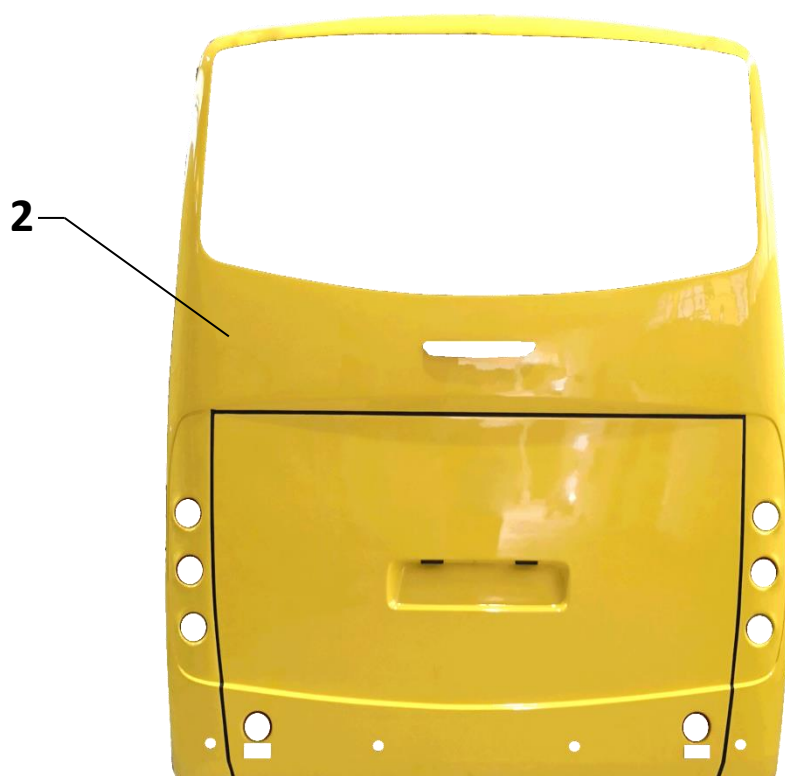
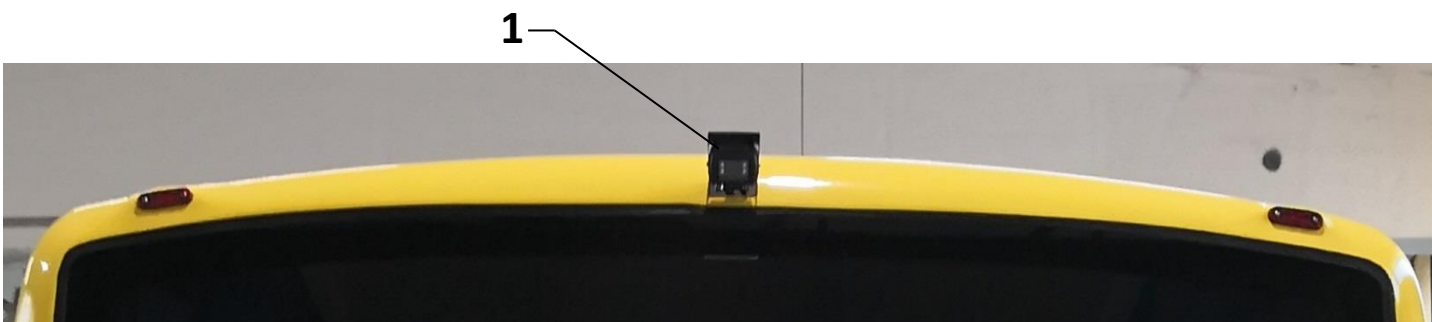

ILLUMINAZIONE ESTERNA POSTERIORE

Sole 100 Scuolabus

pos.	codice	quantità	U.M.	descrizione
1	B160014	2	NR	Luci di ingombro
2	B160012	2	NR	Frecce direzionali
3	B160011	2	NR	Stop posizione
4	B160010	2	NR	Retromarcia
5	B160009	2	NR	Retronebbia
6	B160007	2	NR	Catadiottri
7	B160008	2	NR	Luci targa
8	B160013	1	NR	Terzo stop
1			NR	
2			NR	
11			NR	
12			NR	
13			NR	
14			NR	
15			NR	
16			NR	
17			NR	
18			NR	
19			NR	

IMPIANTO TERGI

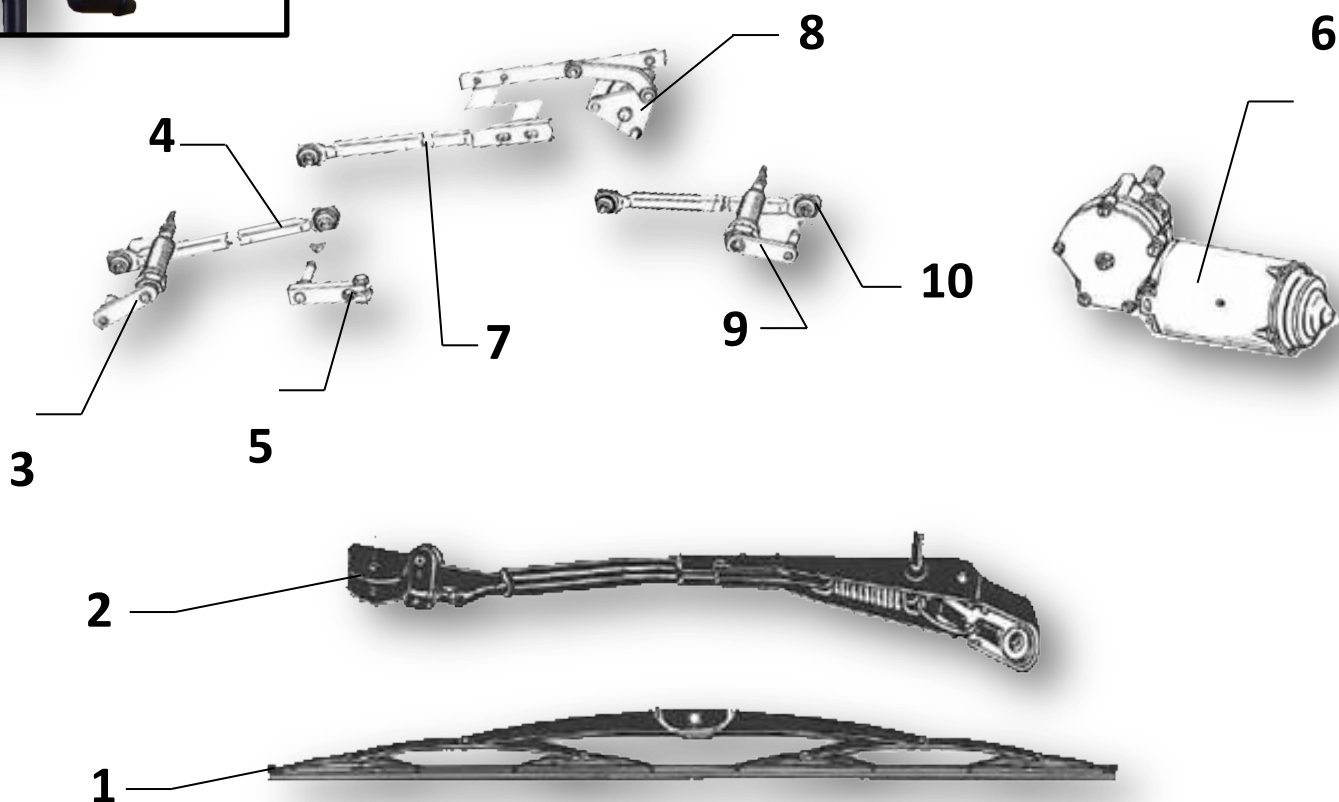
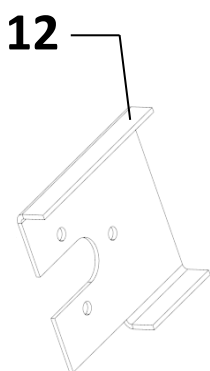

Elementi frontali

Sole 100 Scuolabus

pos.	codice	quantità	U.M.	descrizione
1	B190014	1	NR	Scritta IVECO
2	B190015	1	NR	Adesivo Barbi
3	B346502	1	NR	Paraurti centrale
4	B346501	1	NR	Cofano anteriore
5	B346503	1	NR	Resina ant. Contorno parabrezza
6	B311001	1	NR	Braccio movimento cofano
7	B160102	1	NR	Specchio retrovisore destro completo
8	B160101	1	NR	Specchio retrovisore sinistro completo
9	B190016	2	NR	Scitta adesiva «SOLE»
10	B120001	1	NR	Serratura cofano
11	B120002	1	NR	Serratura con levetta
12			NR	
13			NR	
14			NR	
15			NR	
16			NR	
17			NR	
18			NR	
19			NR	

ELEMENTI FRONTALI

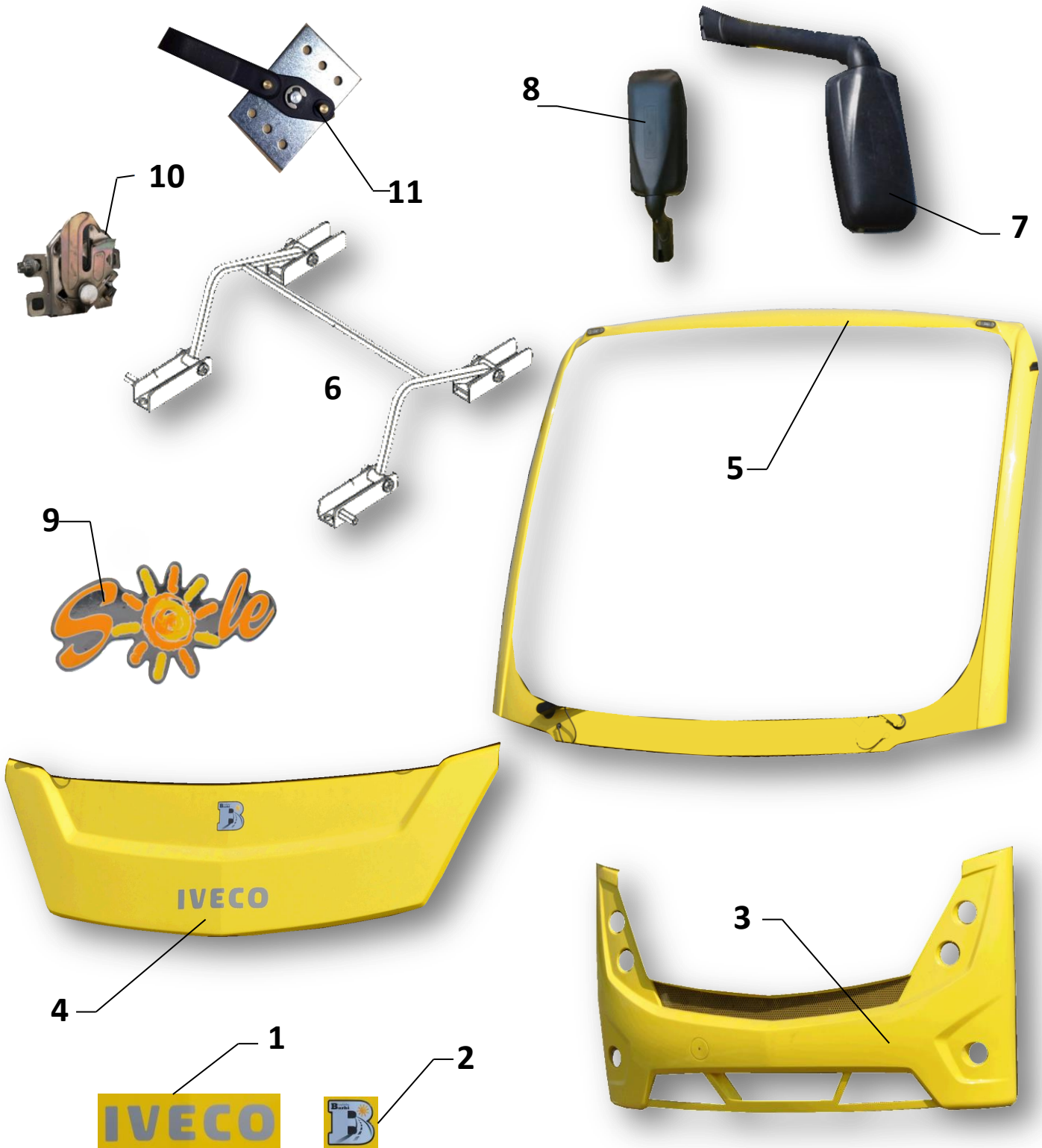

IMPIANTO TERGI

Sole 100 Scuolabus

pos.	codice	quantità	U.M.	descrizione
1	B150001	2	NR	Spazzola dx e sx
2	B150002	2	NR	Braccio dx e sx
3	B150003	1	NR	Perno grande L= 12 CM
4	B150004	1	NR	Staffa L= 36CM
5	B150005	1	NR	Perno piccolo
6	B150006	1	NR	Motore 24v
7	B150007	1	NR	Staffa L=58CM
8	B150008	1	NR	Perno mobile
9	B150009	1	NR	Perno grande L= 10CM
10	B150010	1	NR	Staffa L= 54CM
11	B150011	2	NR	kit spruzzino e tubo
12	B180025	2	NR	Staffa supporto tergi
13	B180026	1	NR	KIT adattatori tergi
14			NR	
15			NR	
16			NR	
17			NR	
18			NR	
19			NR	
				Pag.11

RISCALDAMENTO

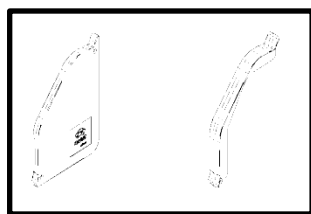

9

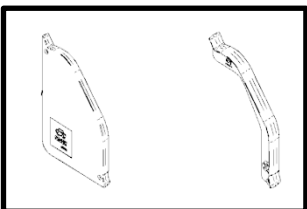

10



11



12

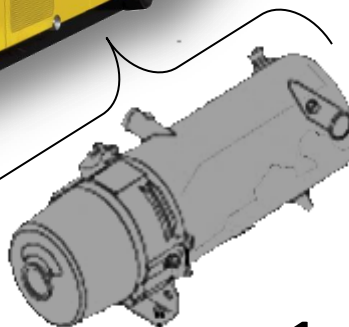

1

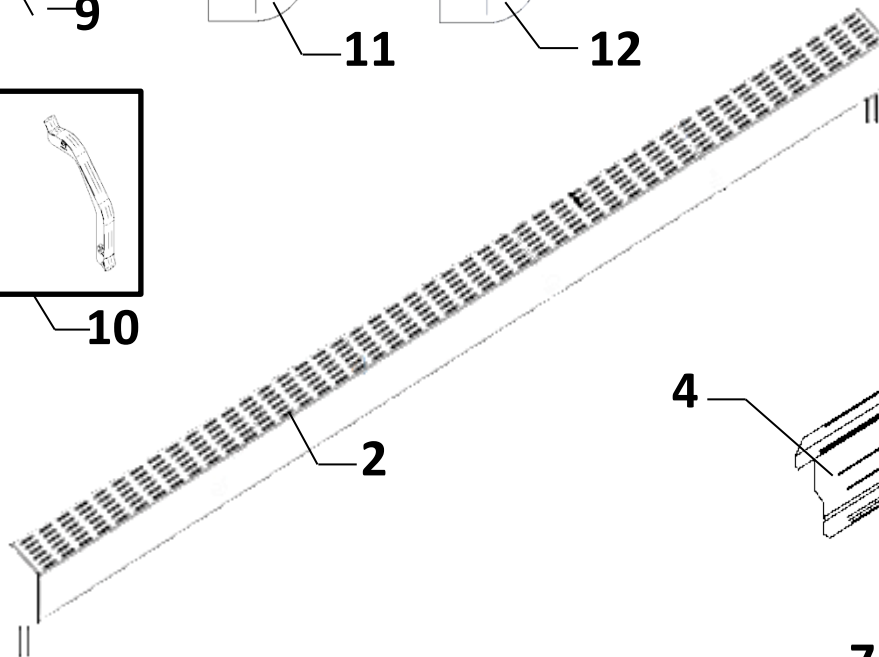

2

4

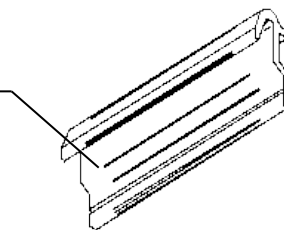

5

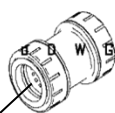

6

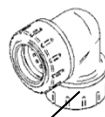

7



8

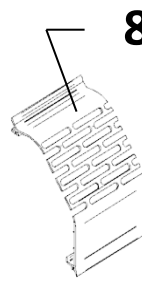

Porta emergenza

Sole 100 Scuolabus

pos.	codice	quantità	U.M.	descrizione
1	B330001	1	NR	Porta emergenza completa
2	B330101	1	NR	Gradino Emergenza
3	B330102	1	NR	Antiapertura
4	B330103	1	NR	Acciaio di protezione
5	B330104	1	NR	Serratura
6	B330105	1	NR	Maniglia emergenza interna
7			NR	
8			NR	
9			NR	
10			NR	
11			NR	
12			NR	
13			NR	
14			NR	
15			NR	
16			NR	
17			NR	
18			NR	
19			NR	

PORTA EMERGENZA

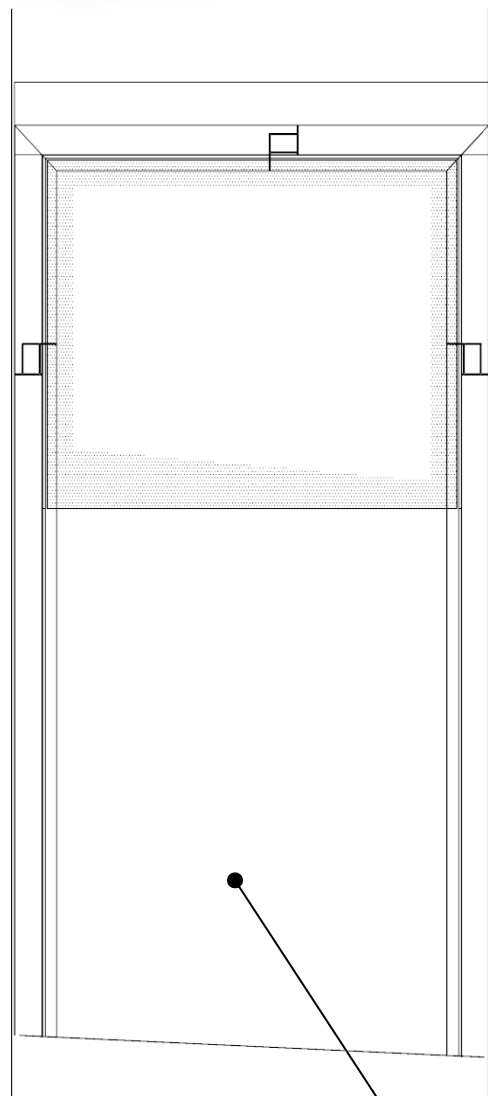
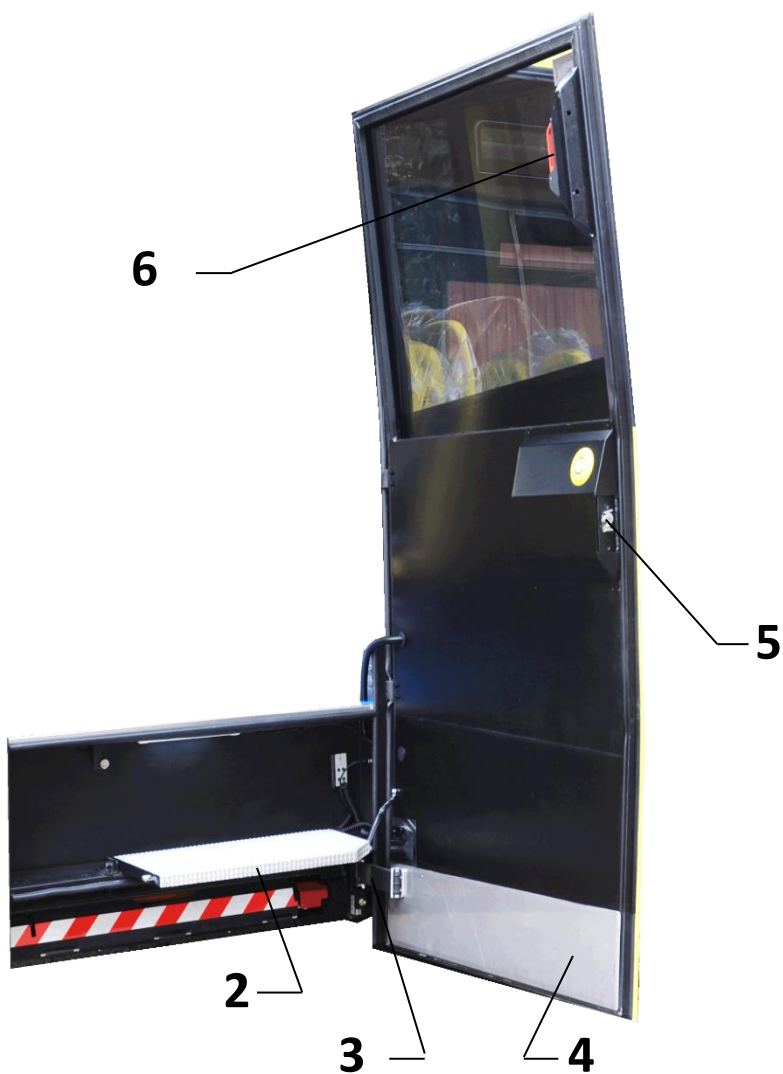

COMPLETA 1

Riscaldamento

Sole 100 Scuolabus

pos.	codice	quantità	U.M.	descrizione
1	B140001	1	NR	Preriscaldatore Eberspacher
2	B140002	1	NR	Radiatore/convettore destro e sinistro
3	/	/	NR	/
4	B140004	1	NR	Supporto profilo
5	B140005	1	NR	Raccordo diritto pvc grigio
6	B140006	1	NR	Raccordo a gomito pvc grigio
7	B140007	1	NR	Profilo copertura
8	B140008	1	NR	profilo copertura con fori
9	B140009	1	NR	Kit copertura convettore lato sx
10	B140010	1	NR	Kit copertura convettore lato dx
11	B140011	1	NR	Raccordo a U con perno
12	B140012	1	NR	Raccordo a U senza perno
13			NR	
14			NR	
15			NR	
16			NR	
17			NR	
18			NR	
19			NR	

CRUSCOTTO E PLANCE

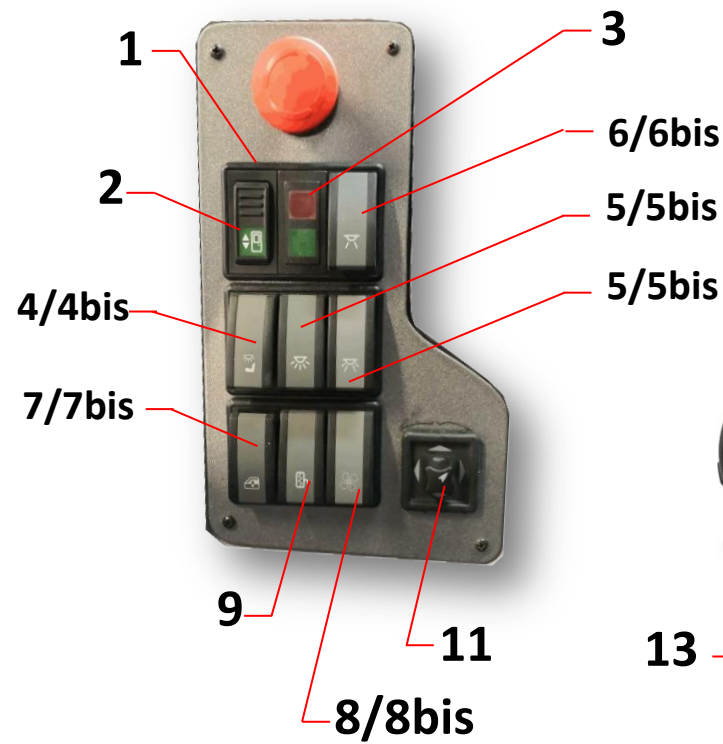

Porta passeggeri

Sole 100 Scuolabus

pos.	codice	quantità	U.M.	descrizione
1	B330100	1	NR	Porta passeggeri completa
2	B346606	1	NR	Scala di salita
3	B146505	1	NR	Apertura esterna porta
4	B330100	1	NR	KIT cilindro apertura porta
5			NR	
6			NR	
7			NR	
8			NR	
9			NR	
10			NR	
11			NR	
12			NR	
13			NR	
14			NR	
15			NR	
16			NR	
17			NR	
18			NR	
19			NR	

PORTA PASSEGGERI



4



3



2

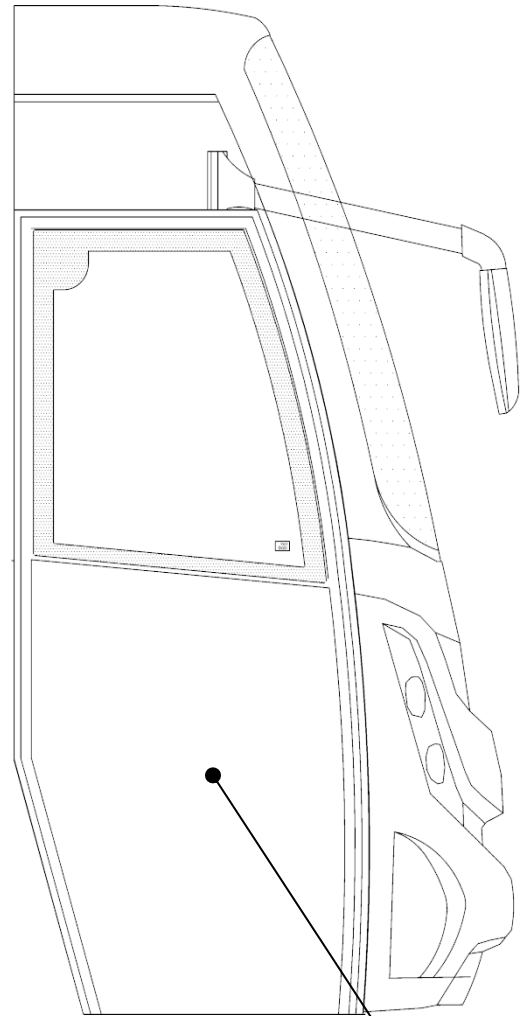

COMPLETA 1

Cruscotto e plance

Sole 100 Scuolabus

pos.	codice	quantità	U.M.	descrizione
1	B150020	3	NR	Cornice porta interruttori a 3 fori
2	B150021	1	NR	Pulsante apertura porta
3	B150022	1	NR	Porta spia doppio apertura porta
4	B150023	1	NR	Interruttore luce autista
4 -BIS	B150024	1	NR	Simbolo luce autista
5	B150025	1	NR	Interruttore luce corridoio
5-BIS	B150026	1	NR	Simbolo luce corridoio
6	B150027	1	NR	Interruttore luce notturna
6-BIS	B150028	1	NR	Simbolo luce notturna
7	B150029	1	NR	Interruttore alzavetro autista
7-BIS	B150030	1	NR	Simbolo alzavetro
8	B150031	1	NR	Interruttore ventilazione
8-BIS	B150032	1	NR	Simbolo ventilazione
9	B150033	1	NR	Interruttore specchi riscaldati
9-BIS	B150034	1	NR	Simbolo specchi riscladati
10	B150035	1	NR	Joystick specchi
11	B150037	1	NR	Centralina A/C (optional)
12	B150036	1	NR	Monitor telecamera retromarcia (optional)
13	B150038	1	NR	Bocchetta tonda diffusione aria lato autista
14	B150039	8	NR	Bocchetta diffusione aria parabrezza
15	B150040	2	NR	

SPORTELLI LATO DX

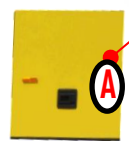

Completo



Completo

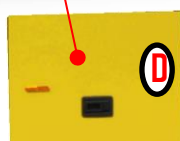

Completo

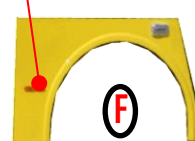

Completo



A

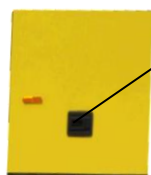

A2

A3



D

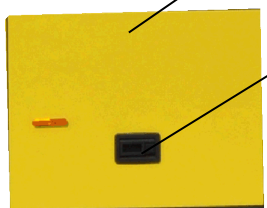

D1

A2

A3



E

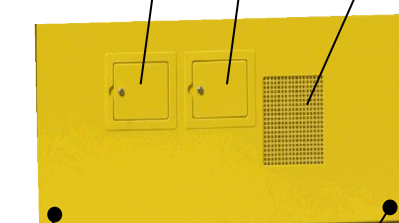

E1

E1

E2

E3

E3

Porta autista

Sole 100 Scuolabus

pos.	codice	quantità	U.M.	descrizione
1	B330002	1	NR	Porta autista assemblata completa
2	B346613	1	NR	Pannello interno copertura porta
3	B330102	1	NR	Tirante anti apertura porta
4	B146504	1	NR	Serratura porta autista
5	B146503	1	NR	Maniglia apertura interna
6	B146501	1	NR	Maniglia presa interna
7	B146502	1	NR	Rete porta documenti
8			NR	
9			NR	
10			NR	
11			NR	
12			NR	
13			NR	
14			NR	
15			NR	
16			NR	
17			NR	
18			NR	
19			NR	

PORTA AUTISTA

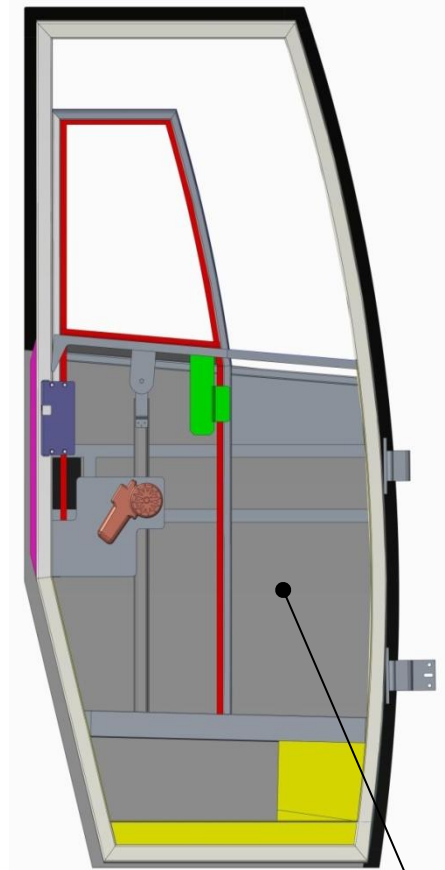
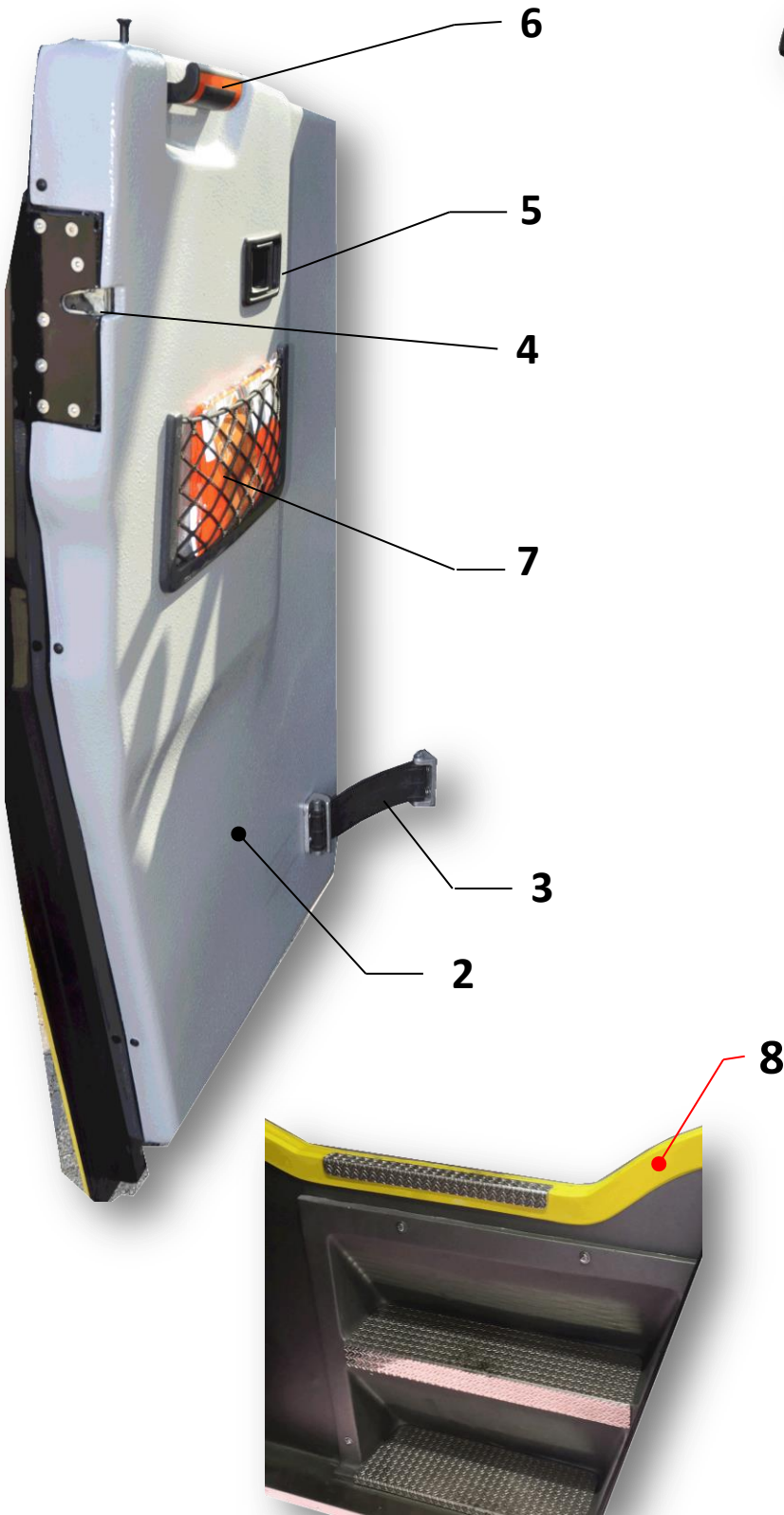

COMPLETA 1

Sportelli lato DX

Sole 100 Scuolabus

pos.	codice	quantità	U.M.	descrizione
A	B380001	1	NR	Sportello completo
A2	B146506	1	NR	Maniglia
A3	B180103	1	NR	Molla a gas
B	B346100	1	NR	Arcoruota posteriore dx
1	B380002	1	NR	Supporto molla a gas fisso
2	B380003	1	NR	Supporto molla a gas mobile
D	B380002	1	NR	Sportello completo
E	B380003	1	NR	Sportello completo
E1	B380010	1	NR	Sportellino gasolio Adblue
E2	B380050	1	NR	Griglia
E3	B380011	1	NR	Serratura chiave quadra
F	B346101	1	NR	Arcoruota lato dx anteriore
		1	NR	
		1	NR	
		1	NR	
		1	NR	
		1	NR	
		1	NR	
		1	NR	

SPORTELLI LATO SX



Completo



Completo



Completo

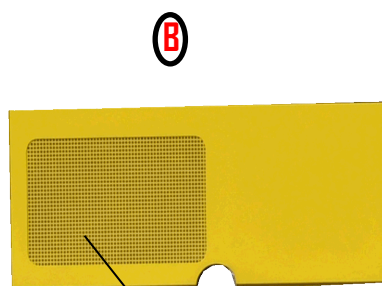

B1

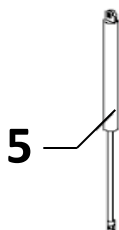

5



7

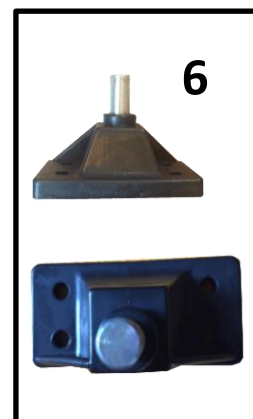

6

Sedili

Sole 100 Scuolabus

pos.	codice	quantità	U.M.	descrizione
1	B390001	1	NR	Sedile biposto destro, cintura a due punti
2	B390002	1	NR	Sedile biposto sinistro, cintura a due punti
3	B390003	1	NR	Sedile biposto destro, cintura a tre punti
4	B390004	1	NR	Sedile Biposto dietro autista (piedi corti)
5	B390005	1	NR	Sedili aggancio rapido biposto (OPTIONAL)
6	B390006	1	NR	Sedili aggancio rapido triposto (OPTIONAL)
7	B390007	1	NR	Sedile monoposto dx
8	B390008	1	NR	Sedile accompagnatore monoposto
9	B390009	1	NR	Sedile accompagnatore biposto
10	B390010	1	NR	Sedile accompagnatore su botola motore
11	B390011	1	NR	Arrotolatore cintura di sicurezza
12	B390011	1	NR	Sedile triposto sx , cintura a due punti
13	B390011	1	NR	Sedile triposto dx, cintura a due punti
14			NR	
15			NR	
16			NR	
17			NR	
18			NR	
19			NR	

SEDILI

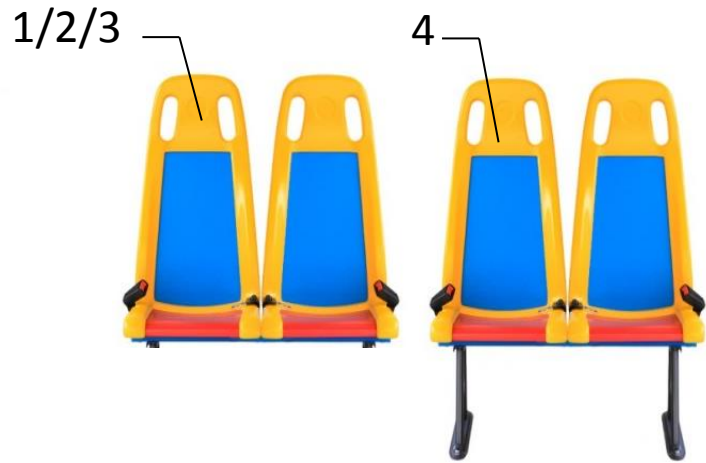
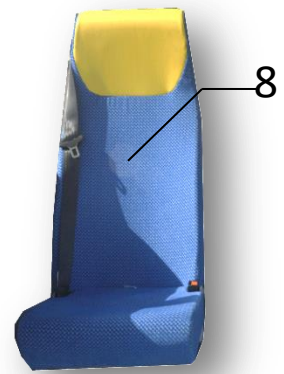
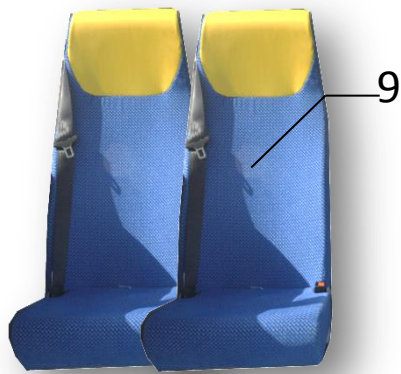

Sportelli lato SX

Sole 100 Scuolabus

pos.	codice	quantità	U.M.	descrizione
A	B346102	1	NR	Arcoruota anteriore sx
B	B380004	1	NR	Sportello completo
B1	B380051	1	NR	Griglia
C	B346103	1	NR	Arcoruota posteriore sx
5	B180103	1	NR	Molla a gas
6	B180101	1	NR	Supporto molla a gas fisso
7	B180102	1	NR	Supporto molla a gas mobile
8			NR	
9			NR	
10			NR	
11			NR	
12			NR	
13			NR	
14			NR	
15			NR	
16			NR	
17			NR	
18			NR	
19			NR	

CRISTALLI

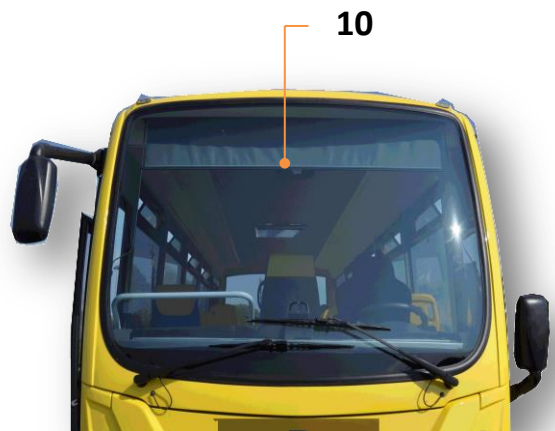
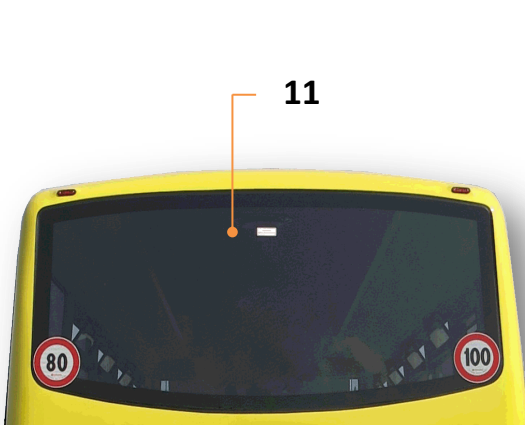
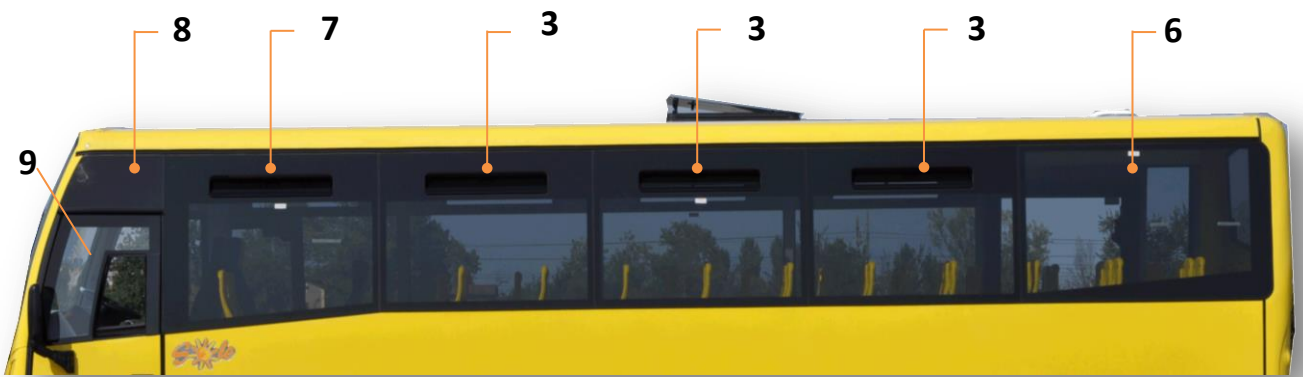
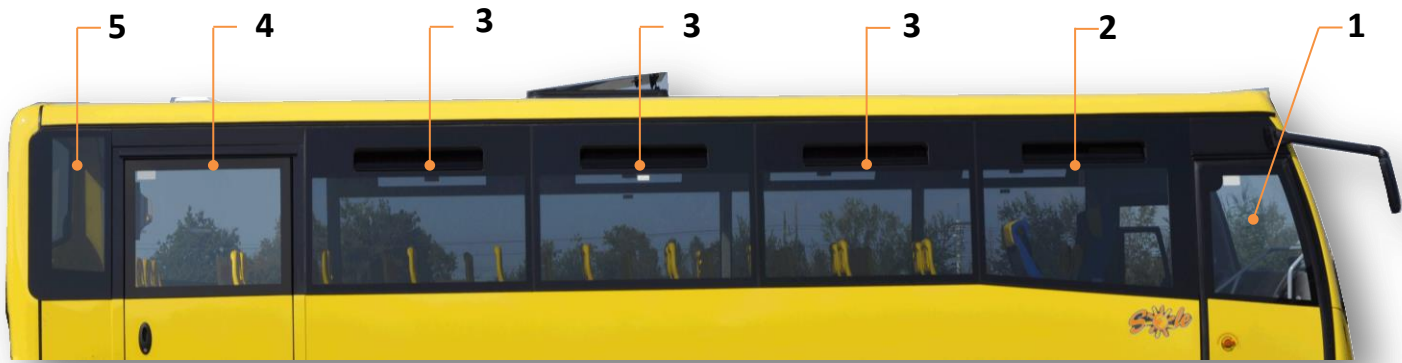

Climatizzazione Autista

Sole 100 Scuolabus

pos.	codice	quantità	U.M.	descrizione
1	B100100	1	NR	Impianto completo aria condizionata
2	B100101	1	NR	Complessivo filtro per abitacolo
3	B100102	1	NR	Guarnizione adesiva
4	B100103	1	NR	Termostato
5	B100104	1	NR	Pulsante inserimento condizionatore
6	B100105	1	NR	Valvola di espansione
7	B100106	1	NR	Briglia per tasto
8	B100107	1	NR	Batteria condensatrice
9	B100108	1	NR	Tubo G10 (1/2") da evaporatore a compressore L. 1750 -
10	B100109	1	NR	Compressore A/C 100, montato in origine su telaio
11	B100110	1	NR	Cinghia compressore A/C 100
12	B100111	1	NR	Guaina per bulbo termostato
13			NR	
14			NR	
15			NR	
16			NR	
17			NR	
18			NR	
19			NR	

CLIMATIZZAZIONE AUTISTA

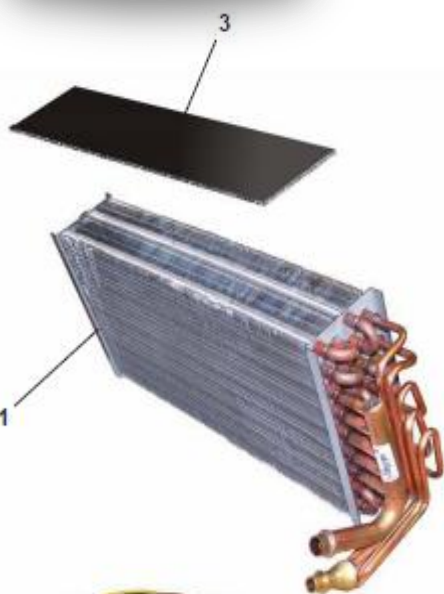
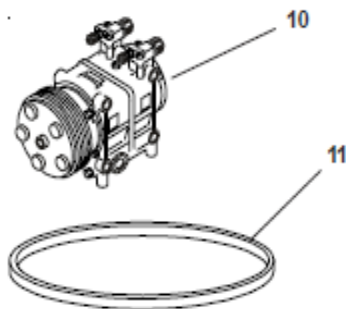

CRISTALLI

Sole 100 Scuolabus

pos.	codice	quantità	U.M.	descrizione
1	B320642	1	NR	Vetro porta passeggeri ant.dx
2	B323153	1	NR	Vetro ant.dx
3	B323151	6	NR	Vetri centrali Dx e SX
4	B320645	1	NR	Vetro porta emergenza
5	B323152	1	NR	Vetro post.dx
6	B323154	1	NR	Vetro post. sx
7	B323150	1	NR	Vetro ant. sx
8	B320647	1	NR	Vetro porta autista fisso
9	B320644	1	NR	Vetro porta autista scendente
10	B323060	1	NR	Parabrezza
11	B323155	1	NR	Lunotto Post.
12			NR	
13			NR	
14			NR	
15			NR	
16			NR	
17			NR	
18			NR	
19			NR	

CLIMATIZZAZIONE

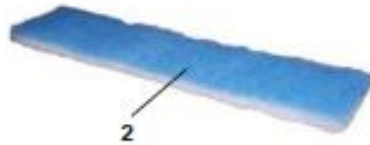

Climatizzazione

Sole 100 Scuolabus

pos.	codice	quantità	U.M.	descrizione
1	B110112	4	NR	Elettroventola evaporatore
2	B110113	1	NR	Filtro per presa aria esterna
3	B110114	1	NR	Attuatore per sportello ricircolo
4	B110115	2	NR	Termostato
5	B110116	2	NR	Valvola di espansione
6	B110117	1	NR	Sensore temperatura
7	B110118	1	NR	Modulo controllo attuatori
8	B110119	1	NR	Batteria condensatrice destra
9	B110120	1	NR	Batteria condensatrice sinistra
10	B110121	2	NR	Elettroventola condensatore
11	B110122	1	NR	Filtro deidratore orizzontale
12	B110123	1	NR	Filtro deidratore orizzontale con attacco per secondo evaporatore
13	B110124	1	NR	Pressostato a tre livelli
14	B110125	1	NR	Copertura condensatori
15	B110126	1	NR	Copertura evaporatori
16	B110127	1	NR	Impianto completo aria condizionata
17		1	NR	
18		1	NR	
19		1	NR	